

Plastic-Encapsulate Diodes

Uni-direction ESD Protection Diode

DESCRIPTION

Designed to protect voltage sensitive electronic components from ESD and other transients. Excellent clamping capability, low leakage, and fast response time provide best in class protection on designs that are exposed to ESD.

The combination of small size, high level of ESD protection makes them a flexible solution for applications such as Digital cameras, cellular phones, and MP3 Players. It is designed to replace multiplayer varistors (MLV) in consumer equipments applications such as mobile phone, notebook, PAD, STB, LCD TV etc.

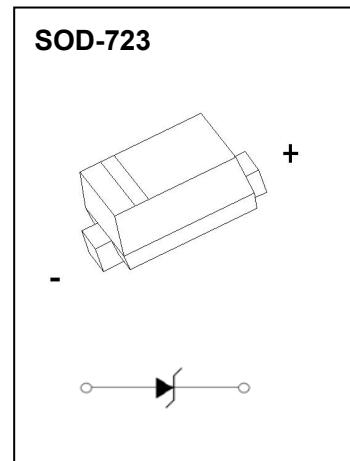

FEATURES

- Uni-directional ESD protection of one line
- Reverse stand-off voltage: 12V
- Low reverse clamping voltage
- Low leakage current
- Excellent package: 1.00mm × 0.60mm × 0.55mm
- Fast response time
- JESD22-A114-B ESD Rating of class 3B per human body model
- IEC 61000-4-2 Level 4 ESD protection

APPLICATIONS

- Computers and peripherals
- Digital Cameras
- Audio and video equipment
- Cellular handsets and accessories
- Portable electronics
- Mp3 Players
- Other electronics equipments communication systems

MARKING

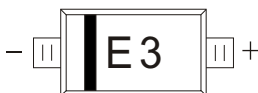

Front side

E3 = Device code

The marking bar indicates the cathode

MAXIMUM RATINGS ($T_a=25^{\circ}\text{C}$ unless otherwise noted)

Parameter	Symbol	Limit	Unit	
IEC 61000-4-2 ESD Voltage	Air Model	± 25	kV	
	Contact Model	± 25		
	JESD22-A114-B ESD Voltage	Per Human Body Model		± 16
	ESD Voltage	Machine Model		± 0.4
Peak Pulse Power	$P_{PP}^{(2)}$	220	W	
Peak Pulse Current	$I_{PP}^{(2)}$	9	A	
Lead Solder Temperature – Maximum (10 Second Duration)	T_L	260	$^{\circ}\text{C}$	
Operation Junction and Storage Temperature Range	T_J, T_{stg}	-55 ~ +150	$^{\circ}\text{C}$	

(1). Device stressed with ten non-repetitive ESD pulses.

(2). Non-repetitive current pulse $8/20\mu\text{s}$ exponential decay waveform according to IEC61000-4-5.

ESD standards compliance

IEC61000-4-2 Standard

Contact Discharge		Air Discharge	
Level	Test Voltage kV	Level	Test Voltage kV
1	2	1	2
2	4	2	4
3	6	3	8
4	8	4	15

JESD22-A114-B Standard

ESD Class	Human Body Discharge V
0	0 ~ 249
1A	250 ~ 499
1B	500 ~ 999
1C	1000 ~ 1999
2	2000 ~ 3999
3A	4000 ~ 7999
3B	8000 ~ 15999

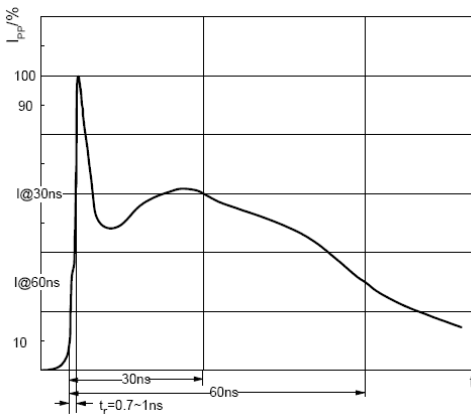

ESD pulse waveform according to IEC61000-4-2

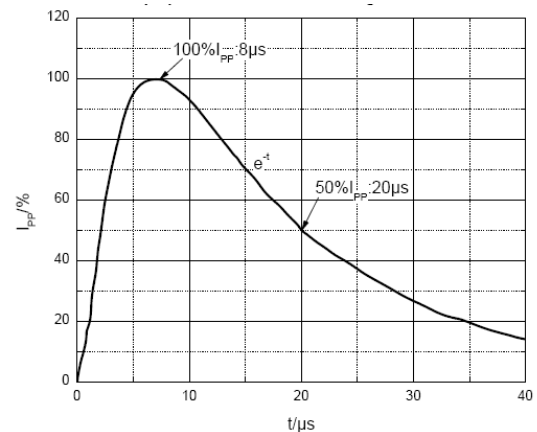

8/20µs pulse waveform according to IEC 61000-4-5

ELECTRICAL PARAMETER

Symbol	Parameter
V_C	Clamping Voltage @ I_{PP}
I_{PP}	Peak Pulse Current
V_{BR}	Breakdown Voltage @ I_T
I_T	Test Current
I_R	Reverse Leakage Current @ V_{RWM}
V_{RWM}	Reverse Standoff Voltage
V_F	Forward Voltage @ I_F
I_F	Forward Current

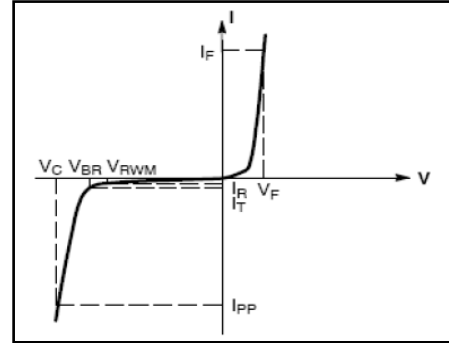

V-I characteristics for a uni-directional TVS

ELECTRICAL CHARACTERISTICS ($T_a=25^\circ\text{C}$ unless otherwise specified)

Parameter	Symbol	Test conditions	Min	Typ	Max	Unit
Reverse stand off voltage	$V_{RWM}^{(1)}$				12	V
Reverse leakage current	I_R	$V_{RWM}=12\text{V}$			1	μA
Breakdown voltage	$V_{(BR)}$	$I_T=1\text{mA}$	13.5		16.5	V
Clamping voltage	$V_C^{(2)}$	$I_{PP}=9\text{A}$			24	V
Forward voltage	V_F	$I_F=10\text{mA}$			0.9	V
Junction capacitance	C_J	$V_R=0\text{V}, f=1\text{MHz}$		45		pF

(1). Other voltages available upon request.

(2). Non-repetitive current pulse 8/20 μs exponential decay waveform according to IEC61000-4-5



CHINA BASE
INTERNATIONAL

SOD-723

ESD7Z12



www.china-base.com.hk

TYPICAL CHARACTERISTICS

Forward Characteristics

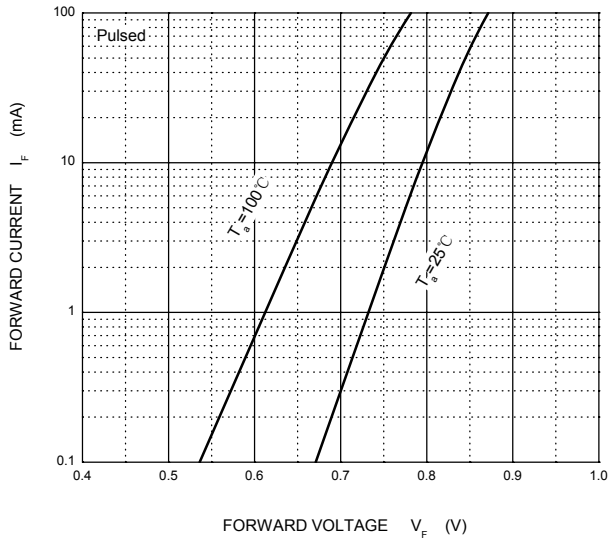

Reverse Characteristics

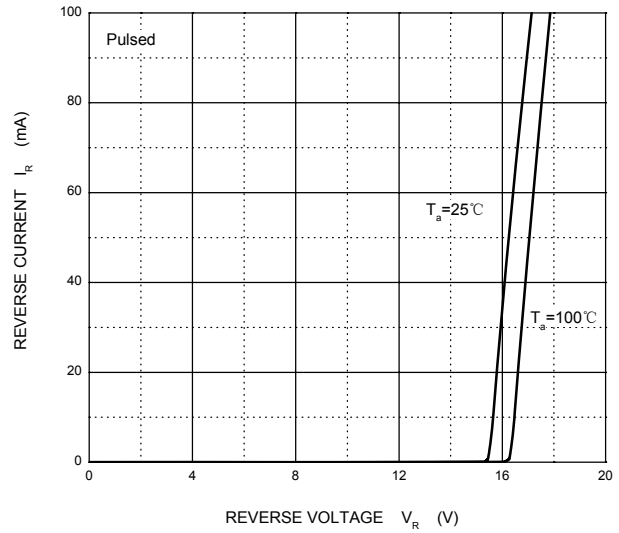

V_C — I_{PP}

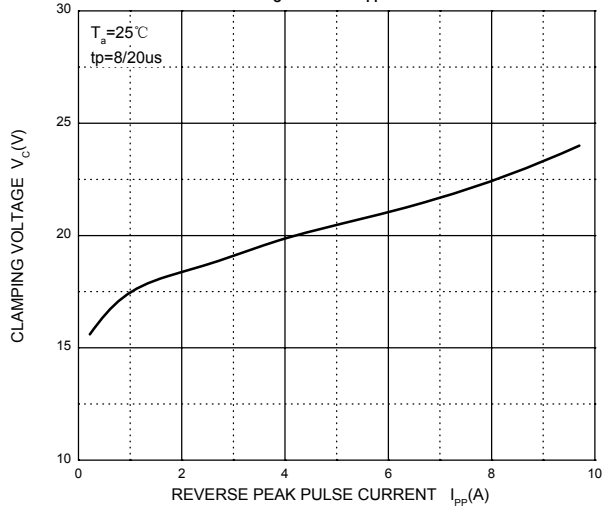

Capacitance Characteristics

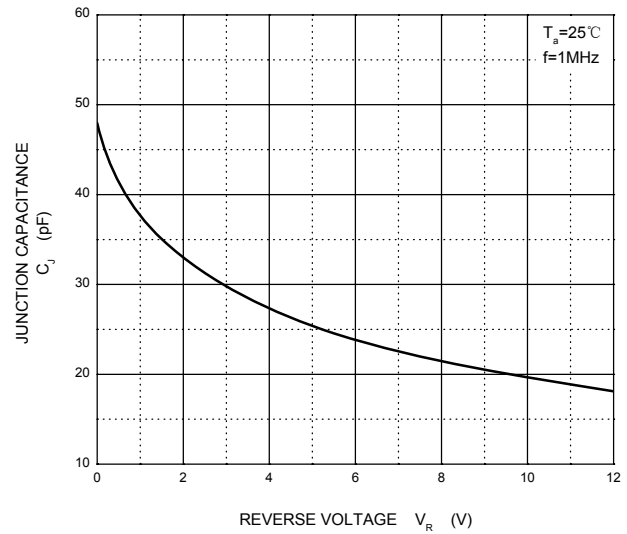

SOD-723-Package Outline Dimensions

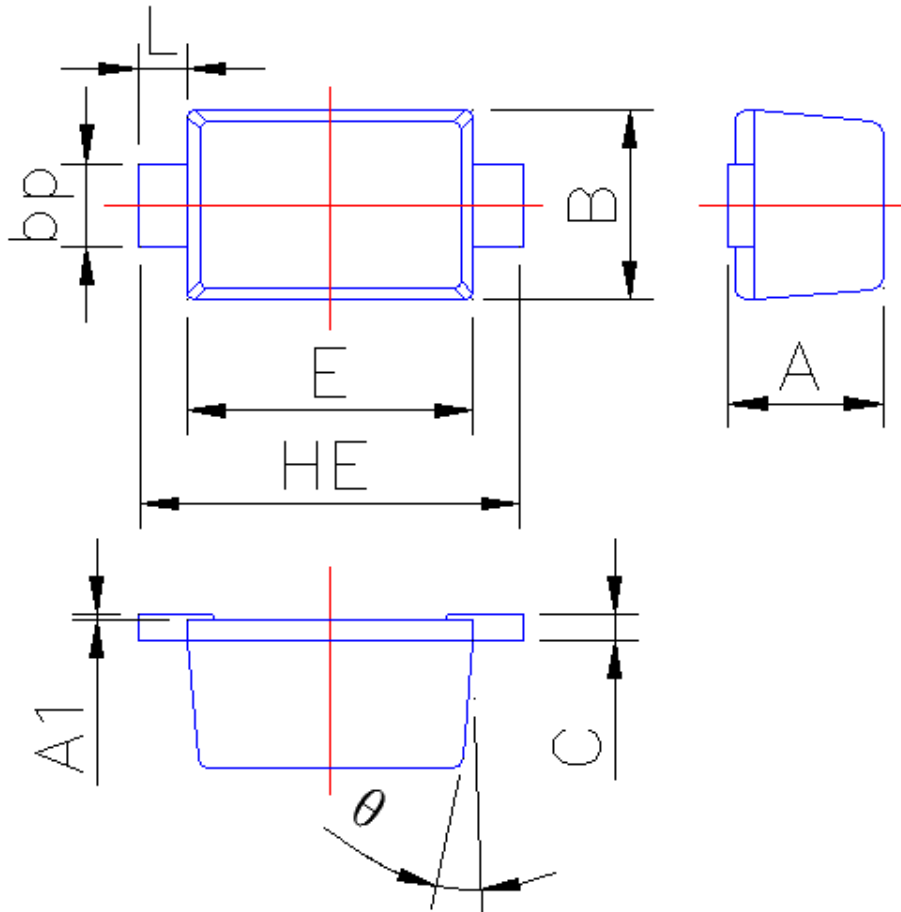

Symbol	Dimension in Millimeters	
	Min	Max
A	0.515	0.580
A1	0.010	0.070
B	0.550	0.650
bp	0.250	0.350
C	0.08	0.150
E	0.900	1.100
HE	1.30	1.50
L	0.150	0.250
θ	7°	